

REV	ECN NO.	DATE
B	N/A	2014/05/20

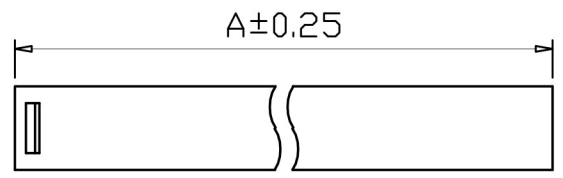

Material:
 Insulator: PBT+25% Glass Fiber (UL94V-0).
 Contact: Copper Alloy.
 Contact Plated: Gold or Tin over Nickel Plated.

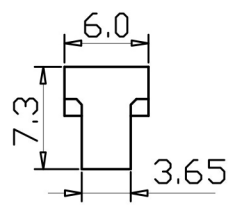
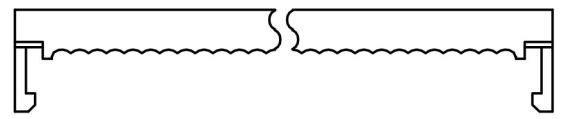

Specification:
 Current Rating: 1 Amp.
 Withstanding Voltage: AC 500V for 1 Minute.
 Insulation Resistance: 1000MΩ Min. at DC 500V.
 Contact Resistance: 15Ω Max..
 Operating Temperature: -40°C ~ +105°C.
 (標※處為重點檢驗尺寸)

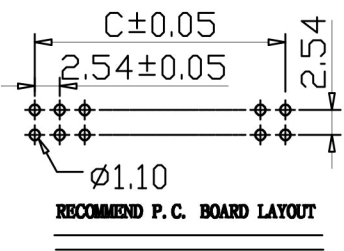
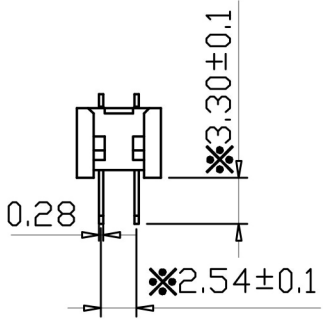
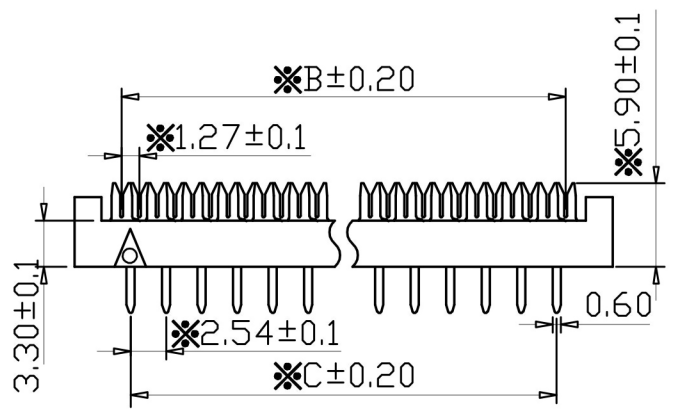

Pos.	Dim. A	Dim. B	Dim. C
6	13.07	6.35	5.08
8	15.61	8.89	7.62
10	18.15	11.43	10.16
12	20.69	13.97	12.70
14	23.23	16.51	15.24
16	25.77	19.05	17.78
18	28.31	21.59	20.32
20	30.85	24.13	22.86
24	35.93	29.21	27.94
26	38.47	31.75	30.48
30	43.55	36.83	35.56
34	48.63	41.91	40.64
36	51.17	44.45	43.18
40	56.25	49.53	48.26
50	68.95	62.23	60.96
60	81.65	74.93	73.66
64	86.73	80.01	78.74

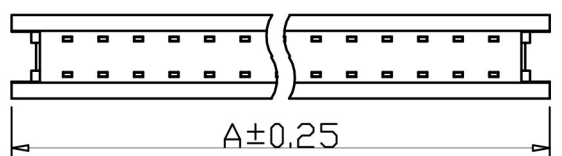

5	SIGNATURE	DATE	TITLE:		CODE NO.	---	TOLERANCE: X ±0.3 .X ±0.2 .XX ±0.10 .XXX ±0.05 ANG.
	DRN.	GRP	2014/05/20	2.54mm DIP Connector	CUS. NO.	---	
	CHK.			Q&T P/N:	UNIT	mm	
	APP.			CUS. P/N:	PAGE	1/1	

DRAWING NO.	
NO	
F/成品圖/DIP系列	